

Eaton SB2262004TG

Catalog Number: SB2262004TG

Eaton B-Line series runway support, Used to support cable runway from objects, Includes 5/16" "J" bolts and nuts., 4" runway support, ASTM A36 structural steel, Telco gray powder coat

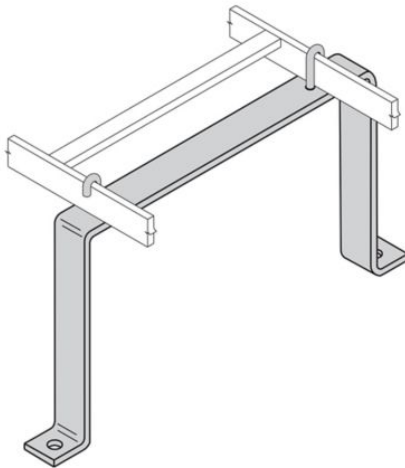

General specifications

Product Name	Eaton B-Line series runway support	Catalog Number	SB2262004TG
UPC	799038289012	Product Length/Depth	23.75 in
Product Height	4 in	Product Width	20 in
Product Weight	2.6 lb	Certifications	UL Listed

Product specifications

Special features

Includes 5/16" "J" bolts and nuts.

Type

Runway support

Material details

Telco gray powder coat ASTM A36 steel

Application

Used to support cable runway from objects

Resources

Brochures

[Redi-Rail runway brochure](#)

Catalogs

[Cable runway and accessories section of datacomm catalog](#)

Specifications and datasheets

[Eaton Specification Sheet - SB2262004TG](#)



Eaton Corporation plc
Eaton House
30 Pembroke Road
Dublin 4, Ireland
Eaton.com
© 2023 Eaton. All Rights Reserved.

Eaton is a registered trademark.

All other trademarks are property of their respective owners.



[Eaton.com/socialmedia](https://www.eaton.com/socialmedia)